

# POHLAD ZHORA M 1:50

TOP ELEVATION  
OBERANSICHT

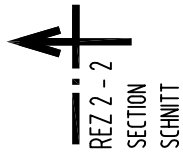

VERZIA S ROLETOU  
ROLLER VERSION

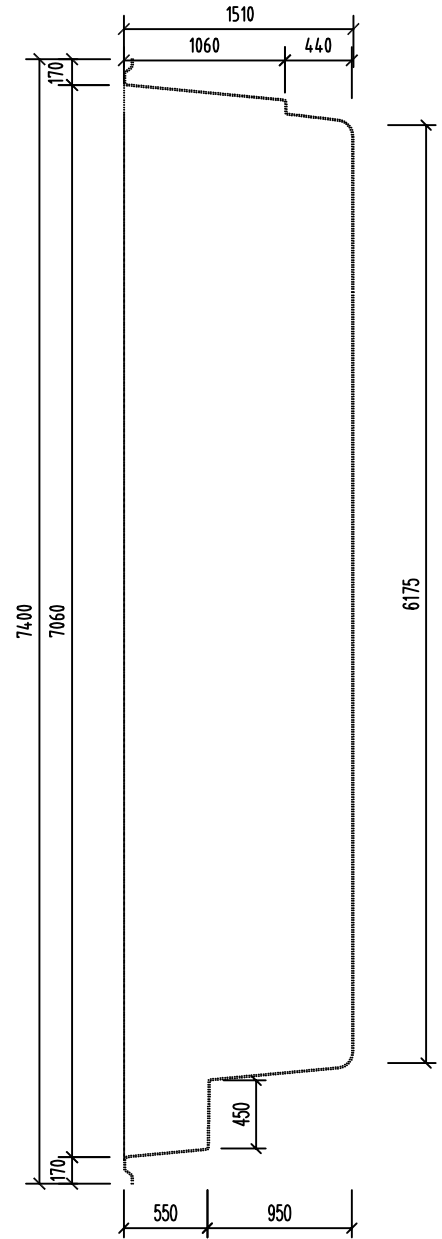
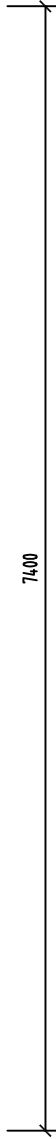
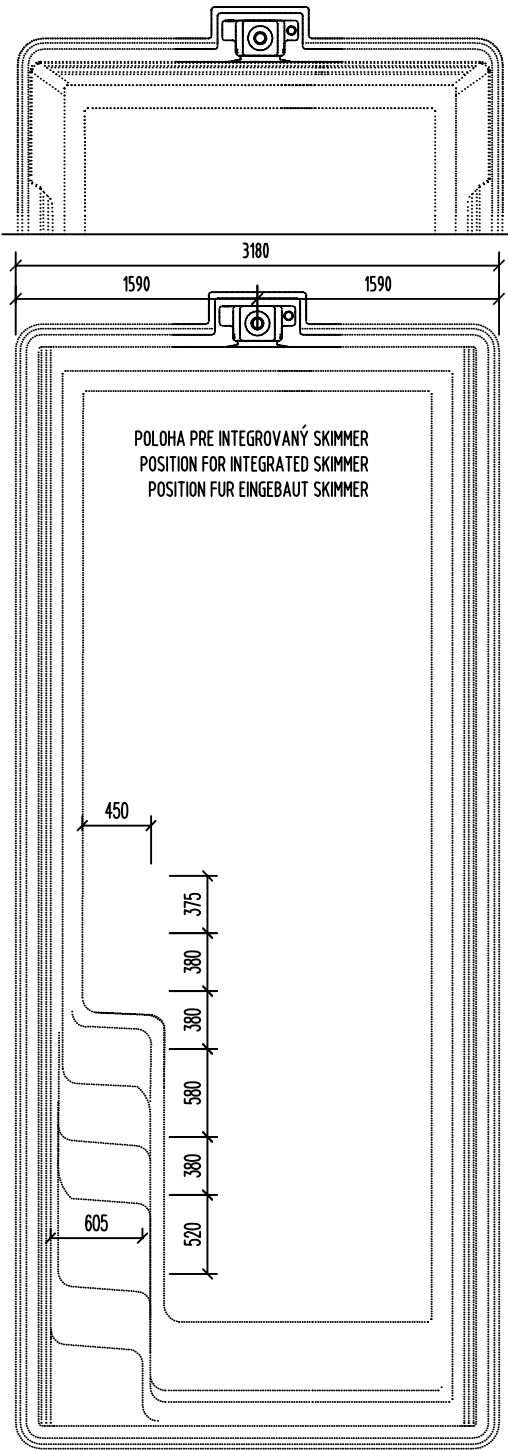

REZ 2 - 2 M 1:50  
LONGITUDINAL SECTION  
QUERSCHNITT

## REZ 1 - 1 M 1:50

CROSS SECTION  
QUERSCHNITT

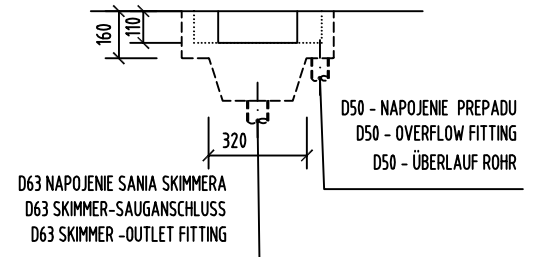
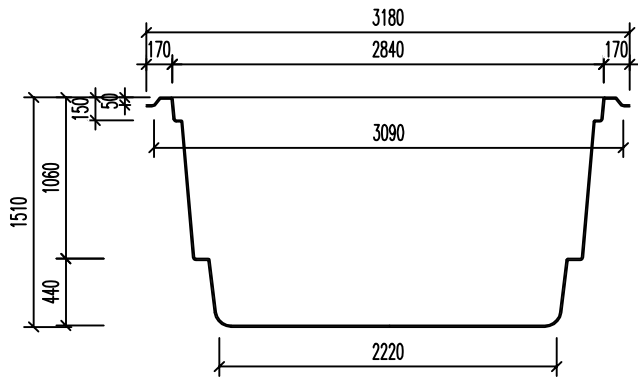

DETAIL ÚPRAVY  
INTEGROVANÝ SKIMMER  
DETAIL FOR INTEGRATED SKIMMER  
DETAIL FÜR EINGEBAUT SKIMMER

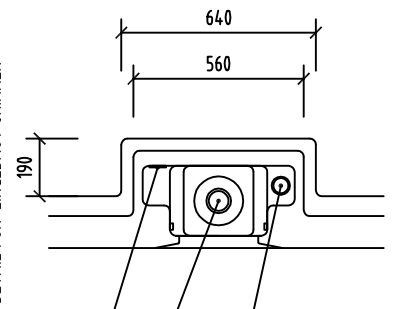

FIXÁCIA PLAVÁKU HLADINY  
FIXATION FOR WATER LEVEL FLOAT  
ELEMENT FIXIERUNG FÜR WASSERHOHE

D63 NAPOJENIE SANIA SKIMMERA  
D63 SKIMMER-SAUGANSCHLUSS  
D63 SKIMMER-OUTLET FITTING

D50 - NAPOJENIE PREPADU  
D50 - OVERFLOW FITTING  
D50 - ÜBERLAUF ROHR

POZNÁMKA / NOTE / ANMERKUNG :

HRÚBKA STENY BAZÉNA JE CCA. 10 MM  
TOLERANCIA PRESNOSTI 7 - 10 MM

THICKNESS OF THE SIDEWALL OF SWIMMING POOL IS APPROX. 10 MM.  
MEASURED WITH TOLERANCE RATE 7 - 10 MM

DIE SCHWIMMBADWAND DÜCKE IS CA. 10 MM.  
DUCKENTOLERANZ IST 7 - 10 MM.

POOL HIGH FOR CONTAINER FOR SEA TRANSPORT IS 3080MM.

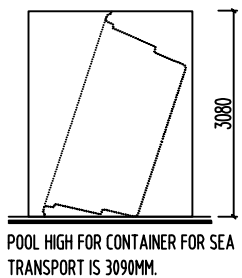

NÁZOV VÝKRESU:  
DRAWING NAME:  
ZEICHNUNG NAME:

CLASSIC 73  
GEOMETRIA BAZÉNA  
GEOMETRY OF SWIMMING POOL  
SCHWIMMBAD GEOMETRIE

COMPASS  
*enjoy the moment*

www.compasspools.eu

KRESLIL: DRAWN BY / ZEICHNER:	ING. PETER KALETA	DÁTUM: DATUM / DATUM:	07/2023
MIERKA: SCALE/MASSTABE:	1:50	FORMÁT DRAWING FORMAT / ZEICHNUNG FORMAT:	A3
VERZIA: VERSION: VERSION:	1	ČÍSLO DRAWING NUMBER: ZEICHNUNG NUMBER:	1

Chyby, tlačové chyby a technické zmeny vyhradené!

Subject to errors, misprints and technical changes!

Irrtum, Druckfehler und Änderungen vorbehalten!